

WATER AND WOOD

HOW MOISTURE AFFECTS WOOD FLOORING

Introduction: When Water and Wood Combine

When the phone rings for the flooring installer, it's often a prospective customer who got the name of the business from a friend. Give an estimate for a new floor? Sure. Getting those kinds of phone calls are good for the business.

But sometimes the caller is a previous customer with a complaint. Perhaps the floor that fit so well when it was first installed now shows cracks, cupping or buckling.

Those are the most common changes that moisture can inflict on a floor. They do no favors for the customer, nor for the hardwood flooring industry. Tales of how floors were damaged by water, for whatever reason — improper installation or careless maintenance

by the owner — leave the impression that wood floors are more problematic than other flooring choices.

For wood flooring professionals, it's important to inform end users about the normal behavior of wood in relation to moisture. Most solid wood flooring will contract during periods of low humidity (usually during the heating season), sometimes leaving noticeable cracks between boards, or else expand during periods of high humidity. To help minimize these effects, users can stabilize the environment of the building through temperature and humidity control.

This publication provides an overview of how water and wood don't mix — and what to do if they do. Spotting any potential moisture problems, and taking the proper steps to avoid them, is the path to the most-serviceable floor. Fortunately, many of the instances that involve moisture can be mitigated before, during or soon after installation.



Excessive moisture in the interior environment or from beneath the floor can cause wood flooring to take on moisture. The result can be a “cupped” floor. For more on cupping, see page 19.

A well-performing wood floor is often the result of an installer taking the proper time and care necessary for a successful installation. It involves a knowledge of:

- the expected moisture content of wood flooring in a particular area after acclimation;
- the moisture content of flooring at the time of installation;
- and the expected “in use” changes.

Moisture is a large part of the reason for how wood behaves, both during the machining process and after installation. Installers would do well to understand moisture's effect on wood in some detail.

Water and Wood Basics

The easy explanation that students learn in grade school — trees grow with roots in the ground and leaves in the air — still serves as the basis for understanding the never-ending relationship between water and wood. The roots collect moisture and nutrients from the soil and ship them through vessels or fibers up the trunk and branches to the leaves. These vessels are similar to the “strings” in a stalk of celery. They are similar, too, to a group of soda straws gathered together, running up and down the tree.

That’s the simple version of how a still-standing tree is made up of vertically-aligned fibers. Cut the tree down, and the fibers are horizontal. Saw it and manufacture strip flooring, nail the floor down and most of the fibers are still horizontal, running the length of the boards.

In the live tree, the fibers are loaded with moisture, as sap. After being cut, the tree begins to dry out, just like a rose will wilt after it’s picked. As the tree’s fibers dry, they shrink in thickness or diame-

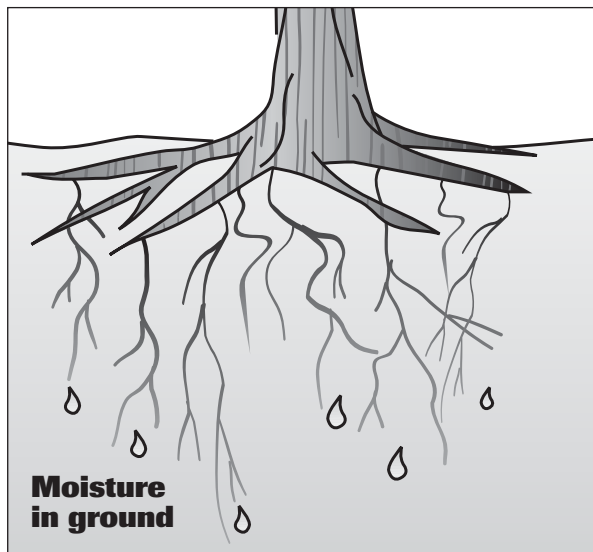

ter, but almost none lengthwise. This shrinkage, characteristic of all woods, is critical in understanding the effect of moisture on wood flooring.

Moisture content in solid wood is defined as the weight of water in wood expressed as a percentage of the weight of oven-dry wood. Weight, shrinkage, strength and other properties depend on the moisture content of wood. In trees, moisture content may be as much as 200 percent of the weight of wood substance. After harvesting and milling, the wood will be dried to the proper moisture content for its end use.

Wood fibers are dimensionally stable when the moisture content is above the fiber saturation point (usually about 30 percent moisture content). Below that, wood changes dimension when it gains or loses moisture. Here are some quick points about shrinking and swelling:

- Shrinkage usually begins at 25 to 30 percent moisture content, the fiber saturation point. Shrinkage continues to zero percent moisture content, an oven-dry state.
- Swelling occurs as wood gains moisture, when it moves from zero to 25 to 30 percent moisture content, the fiber saturation point. Different woods exhibit different moisture stability factors, but they always shrink and swell the most in the direction of the annual growth rings (tangentially), about half as much across the rings (radially) and only in miniscule amounts along the grain (longitudinally). This means that plainsawn flooring will tend to shrink and swell more in width than quartersawn flooring, and that most flooring will not shrink or swell measurably in length.
- Generally, flooring is expected to shrink in dry environments and expand in wetter environments.
- Between the fiber saturation point and the oven-dry state, wood will only change by about .1 percent of its dimension along the grain (lengthwise in a flatsawn board). It will change by 2 to 8 percent across the grain and across the annular rings (top to bottom), if quartersawn; and 5 to 15 percent across the grain and parallel to the annular rings (side to side), if plainsawn.
- Wider boards tend to move more than narrower boards. Movement in a 5-inch-wide plank is more dramatic than in a 2½-inch strip.

The ideal moisture content for flooring installation can vary from an extreme of 4 to 18 percent, depending on the wood species, the geographic location of the end product and time of year. Most oak flooring, for example, is milled at 6 to 9 percent. Before installation, solid wood flooring should be acclimated to the area in which it is to be used, then tested with a moisture meter to ensure the proper moisture content.

(Note: Laminated wood flooring tends to be more dimensionally stable than solid flooring, and may not require as much acclimation as solid flooring prior to installation.)

A wood’s weight and moisture content

Wood is hygroscopic — meaning, when exposed to air, wood will lose or gain moisture until it is in equilibrium with the humidity and temperature of the air.

Moisture content (MC) from 5 to 25 percent may be determined using various moisture meters developed for this purpose. The most accurate method in all cases, and for any moisture content, is to follow the laboratory procedure of weighing the piece with moisture, removing the moisture by fully drying it in an oven (105 degrees C) and reweighing. The equation for determining moisture content is

$$\text{MC}\% = \frac{\text{weight of wood with water} - \text{oven-dry weight}}{\text{oven-dry weight}} \times 100$$

Equilibrium moisture content

The moisture content of wood below the fiber saturation point is a function of both relative humidity and temperature in the surrounding air. When wood is neither gaining nor losing moisture, an equilibrium moisture content (EMC) has been reached.

Wood technologists have graphs that precisely tie EMC and relative humidity together, but as a rule of thumb, a relative humidity of 25 percent gives an EMC of 5 percent, and a relative humidity of 75 percent gives an EMC of 14 percent.

A 50 percent swing in relative humidity produces an EMC change of 10 percent. How that affects wood flooring depends on which species is being used. However, let's say the width variation is just 1/16 inch for a 2 1/4-inch board. That's a full inch over 16 boards in a floor. Over the width of a 10-foot wide floor, that amounts to more than three inches of total expansion or contraction.

Protective coatings cannot prevent wood from gaining or losing moisture; they merely slow the process.

The seasoning of lumber

Freshly sawn lumber begins to lose moisture immediately. Its color will darken and small splits or checks may occur. Movement of moisture continues at a rate determined by many factors, including temperature, humidity and air flow, until a point of equilibrium is reached with the surrounding air. The shrinking and swelling of wood are dimensional changes caused by loss or gain of water.

In practical terms, the process works this way:

1.) A standing oak tree is felled and sawed into a board 1-inch thick, 10 inches wide and 8-feet long. Placed on a scale, the board weighs, say, 36 pounds.

2.) The board is placed in a stack of boards separated from the next by stacking strips of uniform size to keep the board straight. The stack is aimed at the prevailing breezes to accelerate drying. After two or three months of air drying, the board now weighs 25 pounds. It is also 3/32-inch thick, 9 3/4 inches wide and 8 feet long, with 25 percent moisture content.

3.) This 25-pound board is trucked to the flooring mill and loaded into a dry kiln, a building large enough to hold three or four railcar-loads of lumber. After six or seven days, this same board is now 1/16-inch thick, 9.2 inches wide, 8 feet long. It weighs 21.6 pounds with an 8 percent moisture content. If all the moisture were removed, the board would weigh 20 pounds.

The milling of lumber

Most hardwood lumber is dried to an average of 6 to 9 percent moisture content before milling is begun. Mill inspections conducted by the National Oak Flooring Manufacturers Association, allow 5 percent of the wood outside this range, to a maximum moisture content of 12 percent. The 6 to 9 percent range is likely to be the average of all types of wood products used in a normal household environment, assuming usual heating and cooling equipment is used to ensure human comfort.

WOOD FLOORING HAS A COMFORT LEVEL, TOO

Wood flooring will perform best when the interior environment is controlled to stay within a relative humidity range of 30 to 50 percent and a temperature range 60 to 80 degrees Fahrenheit. Fortunately, that's about the same comfort range most humans enjoy. The chart below indicates the moisture content wood will likely have at any given combination of temperature and humidity. Note that equilibrium moisture contents in the recommended temperature/humidity range (shaded area) coincide with the 6 to 9 percent range within which most hardwood flooring is manufactured. Although some movement can be expected even between 6 and 9 percent, wood can expand and shrink dramatically outside that range. See page 6.

MOISTURE CONTENT OF WOOD AT VARIOUS TEMPERATURES AND RELATIVE HUMIDITY READINGS

Temperature (°Fahrenheit)	5	10	15	20	25	30	35	40	45	50	55	60	65	70	75	80	85	90	95	98
30	1.4	2.6	3.7	4.6	5.5	6.3	7.1	7.9	8.7	9.5	10.4	11.3	12.4	13.5	14.9	16.5	18.5	21.0	24.3	26.9
40	1.4	2.6	3.7	4.6	5.5	6.3	7.1	7.9	8.7	9.5	10.4	11.3	12.4	13.5	14.9	16.5	18.5	21.0	24.3	26.9
50	1.4	2.6	3.7	4.6	5.5	6.3	7.1	7.9	8.7	9.5	10.4	11.3	12.4	13.5	14.9	16.5	18.5	21.0	24.3	26.9
60	1.3	2.5	3.6	4.6	5.4	6.2	7.0	7.8	8.6	9.4	10.2	11.1	12.1	13.3	14.6	16.2	18.2	20.7	24.1	26.8
70	1.3	2.5	3.5	4.5	5.4	6.2	6.9	7.7	8.5	9.2	10.1	11.0	12.0	13.1	14.4	16.0	17.9	20.5	23.9	26.6
80	1.3	2.4	3.5	4.4	5.3	6.1	6.8	7.6	8.3	9.1	9.9	10.8	11.7	12.9	14.2	15.7	17.7	20.2	23.6	26.3
90	1.2	2.3	3.4	4.3	5.1	5.9	6.7	7.4	8.1	8.9	9.7	10.5	11.5	12.6	13.9	15.4	17.3	19.8	23.3	26.0
100	1.2	2.3	3.3	4.2	5.0	5.8	6.5	7.2	7.9	8.7	9.5	10.3	11.2	12.3	13.6	15.1	17.0	19.5	22.9	25.6

Chart taken from *Wood Handbook: Wood as an Engineering Material*, (Agriculture Handbook 72), Forest Products Laboratory, U.S. Department of Agriculture.

All the way to the floor

Flooring is usually dried to the national average moisture content expected in use so that shrinkage and swelling are minimized and buckling or large gaps between boards does not occur. However, the careful drying and manufacturing of wood flooring cannot entirely prevent an unsuccessful installation.

Manufacturers who have controlled storage may control the moisture content of the wood up until the point it is placed on the truck for delivery. Various parts of the country have EMCs that range from the dry, desert areas of the Southwest (under 5 percent EMC) to the moist areas along the Gulf of Mexico (over 10 percent EMC). Additionally, a wide range of relative humidities can be experienced between individual job sites in the same locale, such as an ocean-front or lakeside home versus one that's a few miles inland.

Many manufacturers record moisture-meter readings before the flooring leaves the facilities, and such readings are attached to invoice and packing lists. The use of moisture meters, from manufacturing to distribution to installation, is discussed on page 15.

Dimensional stability

When flooring manufacturers and distributors talk about relative stability of various wood flooring species, they are referring to how a floor "moves" once it is put down.

The numbers in the accompanying chart were developed by the Forest Products Laboratory of the U.S. Department of Agriculture. They reflect the dimensional change coefficient for the various species, measured as tangential shrinkage or swelling within normal moisture content limits of 6-14 percent. Quartersawn wood will usually be more dimensionally stable than plainsawn.

The dimensional change coefficient can be used to calculate expected shrinkage or swelling. Simply multiply the change in moisture content by the change coefficient, then multiply by the width of the board.

Example: A red oak (change coefficient = .00369) board 5 inches wide experiences a moisture content change from 6 to 9 percent — a change of 3 percentage points.

Calculation:

$$3 \times .00369 = .01107 \times 5 = .055 \text{ inches.}$$

In actual practice, however, change would be diminished in a complete floor, as the boards' proximity to each other tends to restrain movement.

For a more complete discussion of dimensional stability, see NWFA Technical Publication No. A200: Wood Species Used in Wood Flooring. Write to NWFA at 233 Old Meramec Station Rd., Manchester, MO 63021.

GROWING BOARDS

How much can temperature and humidity affect the dimensions of a hardwood floor? Take a look at one 5-inch red oak plank board:

1) Within "normal living conditions" (say, an interior temperature of 70 degrees and a relative humidity of 40 percent), the board has a moisture content of 7.7 percent and is 5 inches wide.

2) If the relative humidity falls to 20 percent, the moisture content of the board will be 4.5 percent, and the same 5-inch board will shrink by .059 inches. Across 10 feet of flooring, that could translate to as much as 1.4 inches of shrinkage.

3) If the humidity rises to 65 percent, the board's moisture content would be 12 percent and the same 5-inch board would expand by .079 inches. Across 10 feet of flooring, this could translate to 1.9 inches of expansion.

DIMENSIONAL CHANGE COEFFICIENT FOR 23 COMMON WOOD SPECIES

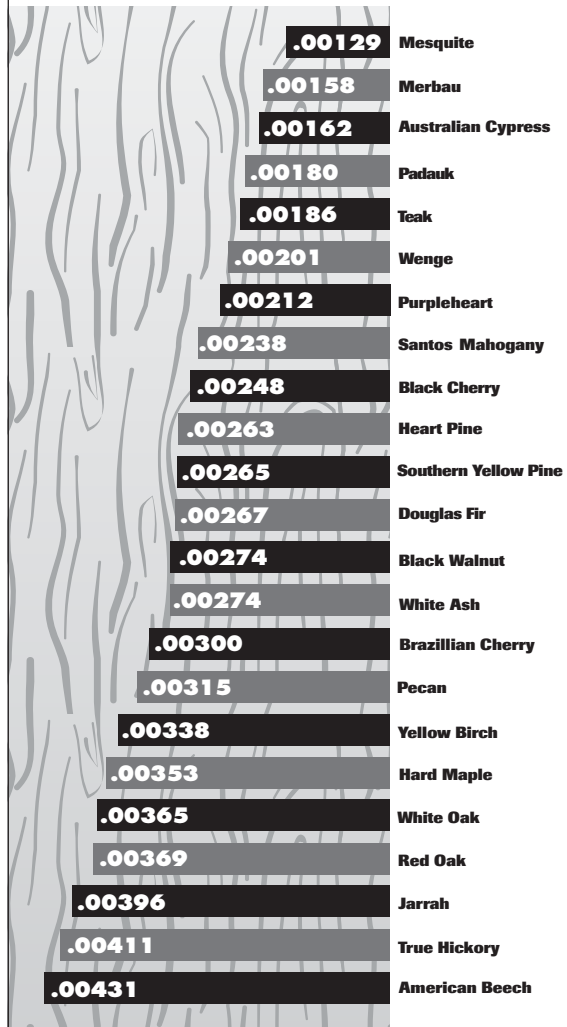

Source: Wood Species Used in Wood Flooring

Sources of Moisture

With the introduction of laminated flooring, hardwood floors can be used in virtually every room in the house, even in basements. Water on or near the building site is still a consideration, however. It cannot be ignored or neglected.

Installing below-grade and on-grade

Moisture comes from a variety of sources — from the earth itself, from surface water (i.e., rain water runoff), as well as from the interior atmosphere. Let's consider the various ways that moisture problems originate, and how they can be controlled and prevented.

A room that is exposed to excessive moisture would be prone to trouble if solid wood flooring were installed in it. Basement floors are particularly tricky installations. But some products, such as laminated flooring, may be suitable in many of these circumstances because of their dimensional stability.

The use of these alternative materials is necessary when the installation is below-grade. "Below grade" is defined as any part of the slab having four inches or more of earth above it. Additionally, walk-out basements are considered a below-grade application, even if a portion of the basement is above ground.

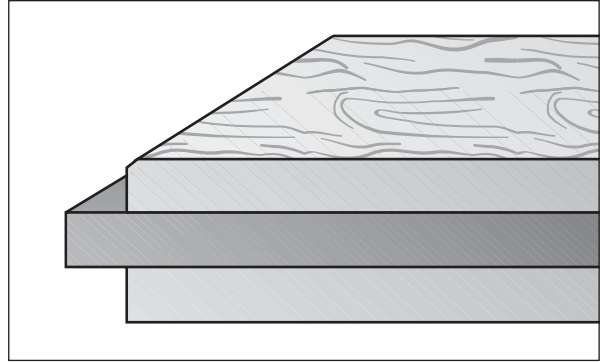

Most laminated (also called engineered) flooring consists of two or more layers of wood glued together, with the grain of each running at 90-degree angles to the layers adjacent. This tends to result in increased dimensional stability.

Use of laminated flooring

Laminated flooring — also called engineered flooring — uses multiple layers of wood glued together, with the grain of each running at 90-degree angles to the layers adjacent. As the wood fibers absorb moisture and want to expand, each layer is restrained by the other and improved dimensional stability results.

Because it displays far less expansion and contraction with moisture changes, laminated flooring can be successfully installed in areas with wide humidity variations. It usually does not require full acclimation before installation.

In on-grade or above-grade installations, various flooring types can be used: solid or laminated. Moisture is still a consideration, although it is less likely to cause problems than in below-grade installations. Once the grade limitations are determined, it's time to look at other potential sources of moisture.

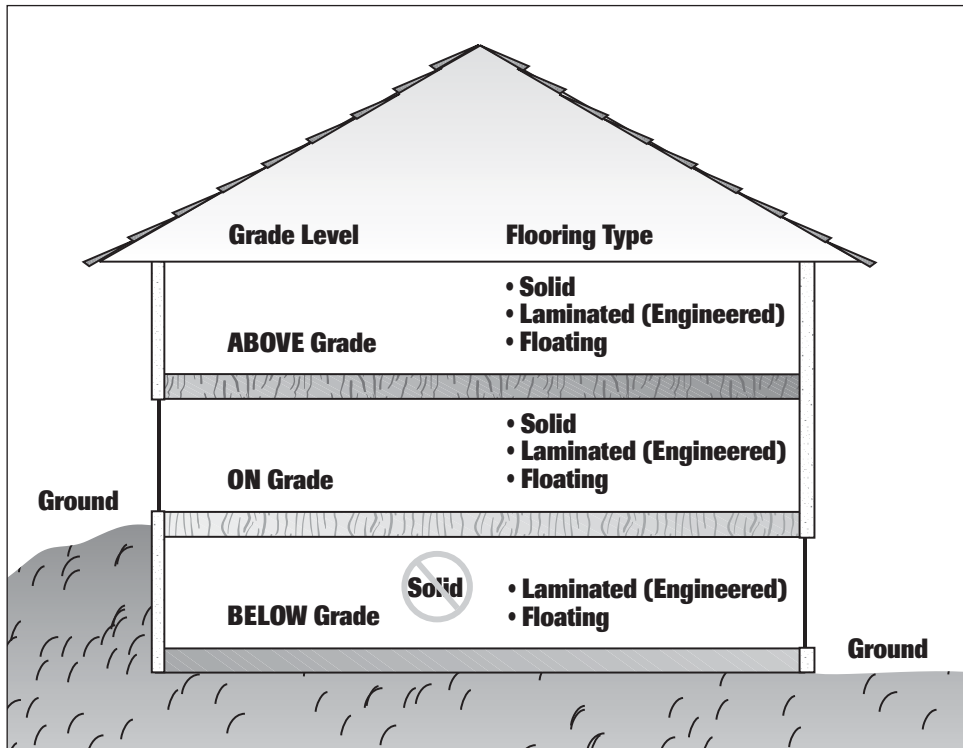

If any part of the soil surrounding a structure is above the floor of any level, consider that level below-grade. This includes walk-out basements. In addition, the surrounding soil should be sloped away from the structure with at least 6 inches of fall over the first 10 feet.

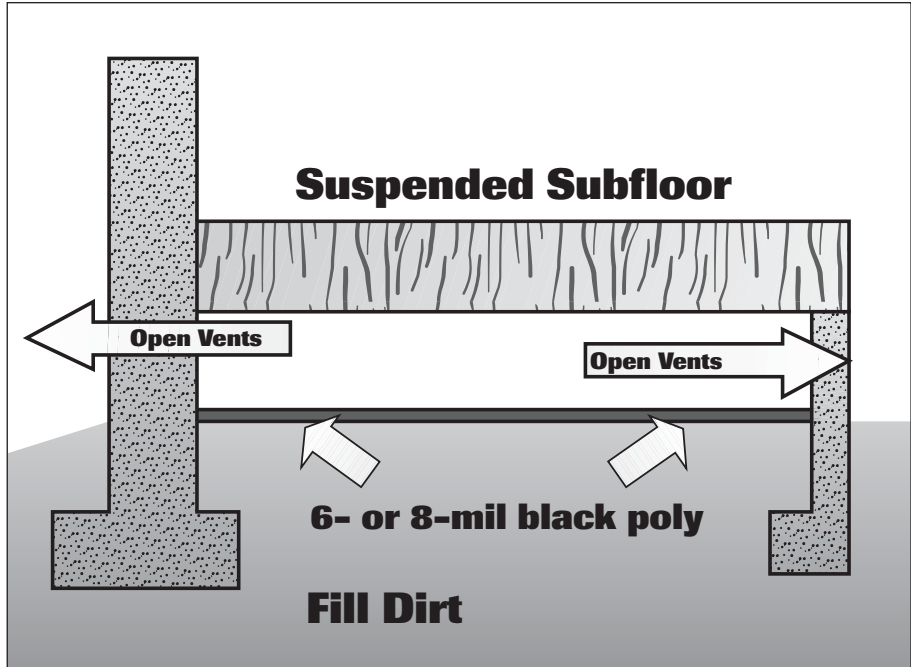

In crawl space construction, 6- or 8-mil plastic (preferably black) should cover the entire ground area.

Potential sources of moisture

NEW CONSTRUCTION: During the building of a new home, moisture can enter the house in a number of ways. When the frame is going up, the 2-by-4s and subfloor materials often get rained on. Because builders usually work on tight, demanding schedules, homes are sometimes built trapping moisture that needs time to evaporate. The amount of moisture introduced by framing lumber and the wet trades can be significant.

GROUND WATER: Sometimes the level of the water in the ground (the water table) is raised above the bottom surface of the foundation due to:

- heavy or prolonged rains;
- a spring that appears only during wet seasons and is not discovered when the house was built;
- water flowing along an impervious layer within the soil.

Any of these may cause water to penetrate the foundation walls or rise through the ground surface into the foundation or crawl space.

SURFACE WATER: Rain water falling on the ground or from the roof can pass through or under the foundation walls. In some areas, heavy soils may retain surface drainage and cause water pressure against the foundation walls or slab.

Surface drainage problems may also occur because the crawl space is below the finish grade outside the house.

CRAWL SPACE: Many houses are built over a crawl space — that is, the floor of the house is built over an

open space that is deep enough to allow a person to gain access to the under-floor area by crawling. The minimum depth of the crawl space should be 24 inches under the floor joists or 18 inches under the girder. An 18-inch clearance beneath any ductwork is also desirable.

Moisture problems within a house that show up as condensation and/or frost on windows in the living area, can result from dampness in the crawl space, or from inadequately vented living space. Moisture problems in crawl spaces may be due to the construction of a crawl space in an area of high water table, improper grading of the lot for drainage or the omission

of moisture control devices such as vapor barriers, ground cover and ventilation openings.

Obvious symptoms of excessive moisture passing upward through the floors may include any of the following: a musty odor; mold on the walls near the floor, in corners and in closets; moisture condensation on insulated windows or storm windows; and moisture condensation in the walls with resulting paint peeling. Some of the more common ways moisture gets into crawl spaces are:

- ground water moving through the foundation walls or up through the earth floor;
- surface water moving through the foundation walls or flowing in through ventilators;
- capillary rise of ground moisture;
- “green” slabs, or concrete foundations that weren’t fully cured when the rest of the house was built above it;

Building codes in most areas requires cross-ventilation in a crawl space equal to at least 1.5 percent of the square foot area within the crawl space.

In addition, a ground cover of 6-mil polyethylene sheets (preferably black) should be placed over the entire area of the crawl space soil, lapped at least 6 inches and held in place by bricks or other weights. (Black polyethylene works better than clear, because the black plastic slows the growth of plants, which can occur even in a relatively dark crawl space. In addition, some wood flooring manufacturers are now recommending 8-mil poly in lieu of 6-mil.)

In cases where concrete is poured to create a floor in the crawl space, the 6- or 8-mil polyethylene cover is still required.

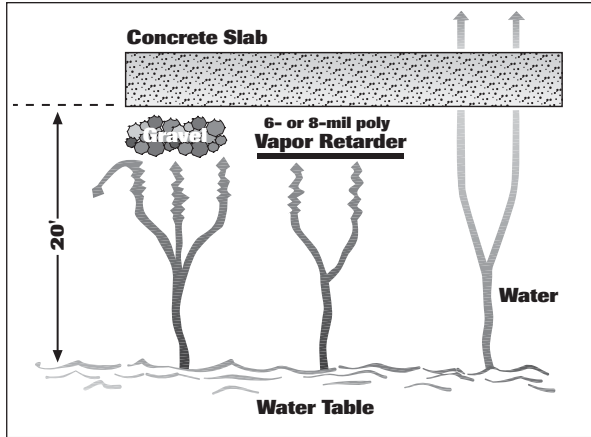

Capillary action causes moisture to travel upward into the slab. Gravel beneath the slab can slow the movement of moisture, but 6-mil plastic below the slab will provide a more effective vapor retarder.

CAPILLARY RISE OF GROUND MOISTURE: Moisture travels upward by capillary action — as much as 14 to 18 gallons per day have been noted under a 1,000-square-foot house — and evaporates within the crawl space. Capillary rise occurs in nearly all areas where the soil is clay or silt.

Capillary action is the effect of surface tension that causes water to rise up a narrow tube, against the effect of gravity. In building construction, capillary action can occur between two surfaces placed together, or within porous materials. This relates to the installation of wood flooring in that moisture can be drawn through both the subfloor and the concrete below it.

It is best not to build below the highest expected water table, for to do so is to have water under pressure trying to enter through any crack or weakness in the construction. Porous granular filling material around and under the building, and connected to drainage lines, can be used to divert drainage water away from the structure.

Making these adaptations is the responsibility of the general contractor. However, the flooring installer who has been hired by the general contractor to do the floors in a new home or building should be aware of these details.

MOISTURE FROM THE HOUSE: There are many sources of moisture from within the house. Mopping the floor in a 150-square-foot kitchen can release the equivalent of 4½ pints of water into the air; a shower or bath about ½ pint; washing the dinner dishes about ½ pint. Also, a family of four gives off about ½ pint of water per hour just breathing (this is why bedrooms are unexpected moisture sources). As moisture is released in a house, it moves to all rooms by natural air movement or by forced air movement from furnace or air conditioning.

MOISTURE FROM MECHANICAL SYSTEMS: Moisture is sometimes introduced into the crawl space from the mechanical systems within the house. To avoid this, make sure the clothes dryer is vented to the

outside. Also, condensate water from cooling systems and water from automatic ice makers should be discharged away from the building.

RELATIVE HUMIDITY: When humidity increases, the effect on the wood floor can be damaging. This occurs most frequently in homes in which occupants are there for a short period of time, such as a weekend home or vacation cabin, or in rooms that are closed off (not heated) to save energy.

If air conditioning or heating is not used or is shut off, ventilation is a must even when the home is not occupied. Otherwise, the floor will expand in the high humidity, and cupping and buckling will occur. This “greenhouse effect” will be exaggerated even more when a plank floor has been installed, because wider boards react to moisture with more movement.

Minimizing moisture from wood subfloors

A heavy moisture invasion can seep up through a wood subfloor. It may occur slowly, but its effects are damaging. Proper installation of flooring calls for checking subfloors for moisture.

To protect against moisture rising through subfloors, the installer needs to make sure there is a proper moisture-vapor retarder.

In any case, the moisture content of solid strip flooring should be within 4 percentage points of the subfloor. (That is, if the subfloor is measured at 10 percent moisture content, the strip flooring should have no less than 6 percent moisture content and no more than 14 percent.) For solid plank flooring, the difference should be no more than 2 percentage points. Solid strip or plank flooring requires a felt paper moisture retarder between the floor and subfloor. If a wood subfloor is laid over an existing slab, the moisture retarder can be cemented to smooth, clean-swept concrete.

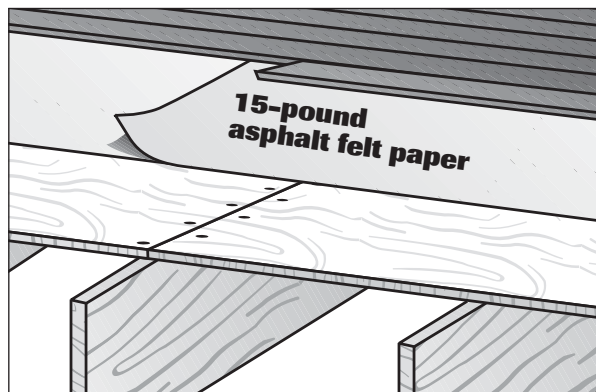

In joist construction, a vapor retarder of 15-pound saturated felt paper should be laid between the wood flooring and the wood subfloor. If the wood subfloor is laid over a concrete slab, the felt paper moisture retarder can be cemented to smooth, clean-swept concrete. Other vapor barriers or retarders may also be appropriate over concrete slabs. See page 10.

Minimizing moisture from concrete

Traditional construction of homes tend to have regional variations. While many of the older homes in New England, the Mid-Atlantic and Midwest regions have basements, most Southern home-building is done on concrete slabs. The slab rests on a carefully prepared base and is usually surrounded by a footing that runs below the frostline, providing the actual foundation for the house.

The no-basement design eliminates many of the moisture problems associated with basements and below-grade features, obviously. But the installation of flooring over concrete is not without its own intricacies. Concrete appears to the untrained eye to be a solid, impermeable foundation, yet it's actually a source in itself for moisture. Concrete expands when it absorbs moisture in humid weather or by exposure to rain, and it contracts again when the moisture evaporates.

All concrete surfaces regardless of age or grade level will emit or conduct some degree of moisture, usually in the form of a vapor. This is a very natural and necessary function of healthy concrete — it's like continual "breathing." However, too much moisture emission without a proper moisture barrier has resulted in flooring failures. Many times the blame for this is placed on a faulty product, improper specification or faulty workmanship, when the real reason lies with slab vapor emission conditions.

Moisture conditions are not the flooring contractor's responsibility. Yet, the contractor should take the initiative to determine potential problems and advise the customer of available remedies before the start of installation.

Concrete is composed of crushed rock, gravel, sand, cement and water. The introduction of water into a cement batch will begin a series of perpetual chemical interactions. The basic recipe for building concrete is completely dependent on water being present in the slab.

Water in concrete is necessary to continue the process of cement curing well past the first few critical weeks. Therefore, all slabs should be tested for moisture before the floor's installation.

Both on-grade or below-grade slabs need time to both cure and dry out enough to handle flooring. General guidelines suggest that 60 days is sufficient for the curing to occur, and floors can be installed after this. These figures, however, are influenced by a number of variables, and should not be used as the sole criterion as to whether or not it is safe to install a floor. Above-grade slabs poured in metal pans take significantly longer to dry and have been known to require several months to well over a year to be safe to install upon. Since drying times are influenced by many factors, it is necessary to conduct proper moisture tests regardless of the slab age or grade level. (See "Testing concrete," page 16.)

Because moisture can rise through concrete by capillary action, moisture-vapor barriers and moisture retarders need to be part of the installation process. Laid between the base of gravel or crushed stone and the slab, this barrier is usually in the form of heavy plastic, uninterrupted film. This film prevents the penetration of moisture through the slab to the interior surface, where it can ultimately damage hardwood floors.

Additionally, another moisture barrier or retarder should be placed on top of the slab before installation. A few choices for the barrier are:

- 1.) Low end PVC vinyl applied over the slab in multipurpose adhesive with seams sealed and the surface prepared before spreading the wood adhesive. The use of this method requires dependence upon the water-soluble, multipurpose bond in the presence of moisture and wood adhesives that are accepted over vinyl. This may also require a vinyl blocker.
- 2.) Polyfilm — 6-millimeter polyethylene film in 36-inch or 48-inch wide rolls — applied over a "skim" coat of asphalt mastic. The mastic should be troweled with a straight-edge trowel to skim coat the slab, with coverage of about 80-100 square feet per gallon. After about 30 minutes, during which the solvents flash or evaporate, the polyfilm can be rolled over the mastic by walking over the film, embedding it in the mastic. Air bubbles that form under the film can be forced out toward the seams with a push broom.
- 3.) 15-pound roofing felt in asphalt mastic applied with a notched trowel at the rate of 50 square feet per gallon. A second similar coating of mastic and asphalt felt should be added, with overlaps staggered to achieve a more even thickness.

There are several other moisture barrier systems available, including two-part epoxy, rubberized elastomeric membrane, and other sealing liquids.

In all cases, installers must verify acceptability of a particular system with the flooring manufacturer, and also verify adhesive compatibility when planning to glue down over any moisture barrier. If you are not familiar with the system, check with the adhesive manufacturer, the flooring manufacturer and the manufacturer of the moisture barrier system before attempting an installation.

Wood's Acclimation

The point of acclimating wood flooring before installing it is to allow the moisture content of the wood to adjust to “**normal living conditions**” at the site — that is, the temperature and humidity conditions that will typically be experienced once the structure is occupied.

Thus, it does no good at all — in fact, it is likely harmful — to store wood flooring at the jobsite under conditions that don't reflect those normal environmental conditions.

The wood flooring industry has done a good job in recent years communicating the message that wood flooring is a dynamic material subject to changes in dimension as a result of changes in humidity in the surrounding environment. That has led to increasing awareness of the need to acclimate wood flooring before installation. Unfortunately, some installers have heard the message as, “Leaving wood flooring at the jobsite for two weeks will properly acclimate the wood, no matter what the conditions are.”

In truth, some wood flooring may already be at the proper moisture content when it's delivered. To allow it to sit at the jobsite under excessively humid conditions will only cause the flooring to absorb unwanted moisture.

So, the key message is not that acclimation is good, and that's all you need to know. Rather, installers need to understand the dynamics of water and wood and make educated judgments about when and how much acclimation is required. To do so requires knowing what the moisture content of the flooring is at the time of delivery and what its expected moisture content will be “in use.”

Wood at the warehouse

Once milled, the flooring should be stored in dry, well-ventilated warehouses before shipment to jobsites. These are some recommended guidelines for handling and storing hardwood flooring:

- *Unloading:* Flooring should be unloaded in good, dry weather, never in the rain.
- *Warehousing:* Flooring should be stored in an enclosed, well-ventilated building and located in areas where similar fine millwork is stored. The storage area within the building should be clean and dry. The stacks of flooring should have good air circulation and no water drainage nearby.
- *Preventing condensation:* When air in a building is more humid than outside air, moisture may form on the underside of the non-insulated roof and affect flooring. Insulation in the roof or walls can prevent condensation.

A covered area can also provide protection, although this is not a guarantee in a damp season or

environment. If this is not possible, all top pallets should be covered with polyethylene film or other water-proof covering.

The storage building should ideally have controlled humidity. Continual dry heat may dry flooring below its desirable moisture content, which could result in buckled floors if flooring is installed without proper acclimation. Conversely, storage in a damp area can introduce unwanted moisture and expansion in the flooring, which could result in unacceptable cracks between boards if flooring is installed without proper acclimation.

Wood at the jobsite

Before wood is delivered, the jobsite must be checked to determine if it is ready. Wood should not be delivered if jobsite moisture conditions are excessive. Otherwise, one will absorb moisture from the other.

The structure should be fully enclosed, with doors and windows in place, and interior climate controls should be operating for at least 48 hours to stabilize the moisture conditions of the interior. Once at the jobsite, the wood should be set indoors and spread over the subfloor. About four days should pass before an installation is started. Moisture contents of both the flooring and the subfloor must be checked and recorded before any work begins.

If flooring is delivered on a damp day or during rain, the boards will absorb moisture. If installed in this condition, the flooring will shrink a few months later and show cracks.

Wood flooring should not be delivered to the jobsite until plastering and painting are completed and dried. Moisture evaporates from damp walls into the air within the house, and some of it will be absorbed by the flooring.

Another condition that causes flooring to pick up moisture during construction is less obvious, but more common: If the heating or air conditioning is not operating from the time the floor is installed until the house occupied, the humidity may be higher than it would be if the house were occupied.

Only after getting satisfactory moisture measurements from the concrete slab and the subfloor, and only after wood has acclimatized to the jobsite, is the installer ready to install. When installation is completed, good practice calls for a delay of one or more weeks for further acclimation before beginning the sanding and finishing part of the job.

On page 14 is a “Builder's Checklist” that can assist as a pre-installation evaluation of the jobsite. Problems identified while completing the checklist should be brought to the attention of the general contractor or owner before installation is begun.

MOISTURE MAP OF

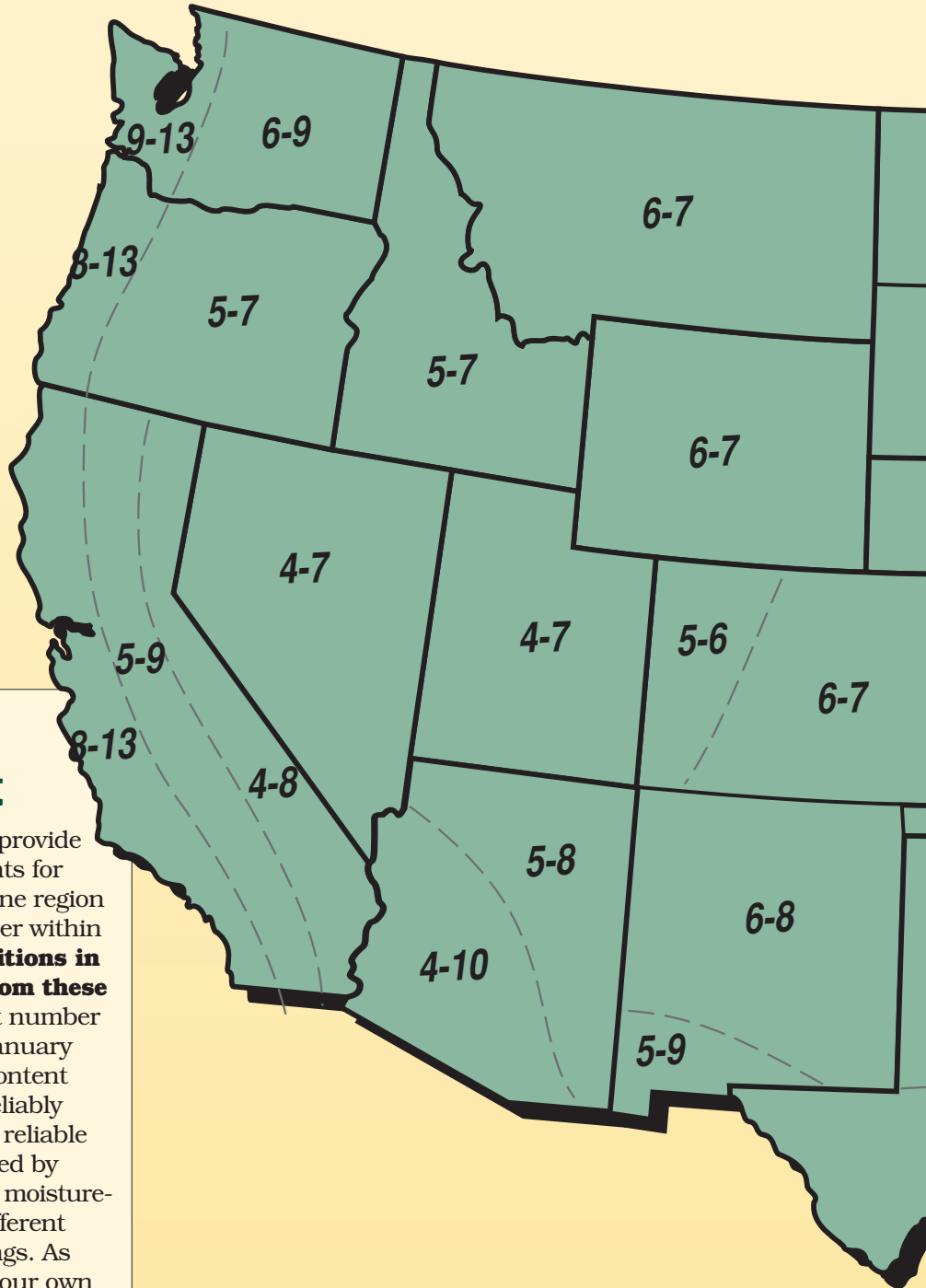

Regional variations of moisture content

The numbers on the accompanying map provide examples of how average moisture contents for interior use of wood products vary from one region to another, and from one season to another within a region. **Actual moisture content conditions in any location may differ significantly from these numbers.** In each pair of figures, the first number is the average moisture content during January and the second is the average moisture content during July. These numbers cannot be reliably used as a basis for installation. The most reliable moisture-content numbers can be obtained by building your own historical records. Take moisture-content readings at various jobsites at different times of the year, and record those readings. As time goes on, you will be able to refer to your own records for guidance in establishing safe moisture-content levels for wood flooring before you install.

Source: The US Department of Agriculture Forest Products Laboratory

THE UNITED STATES

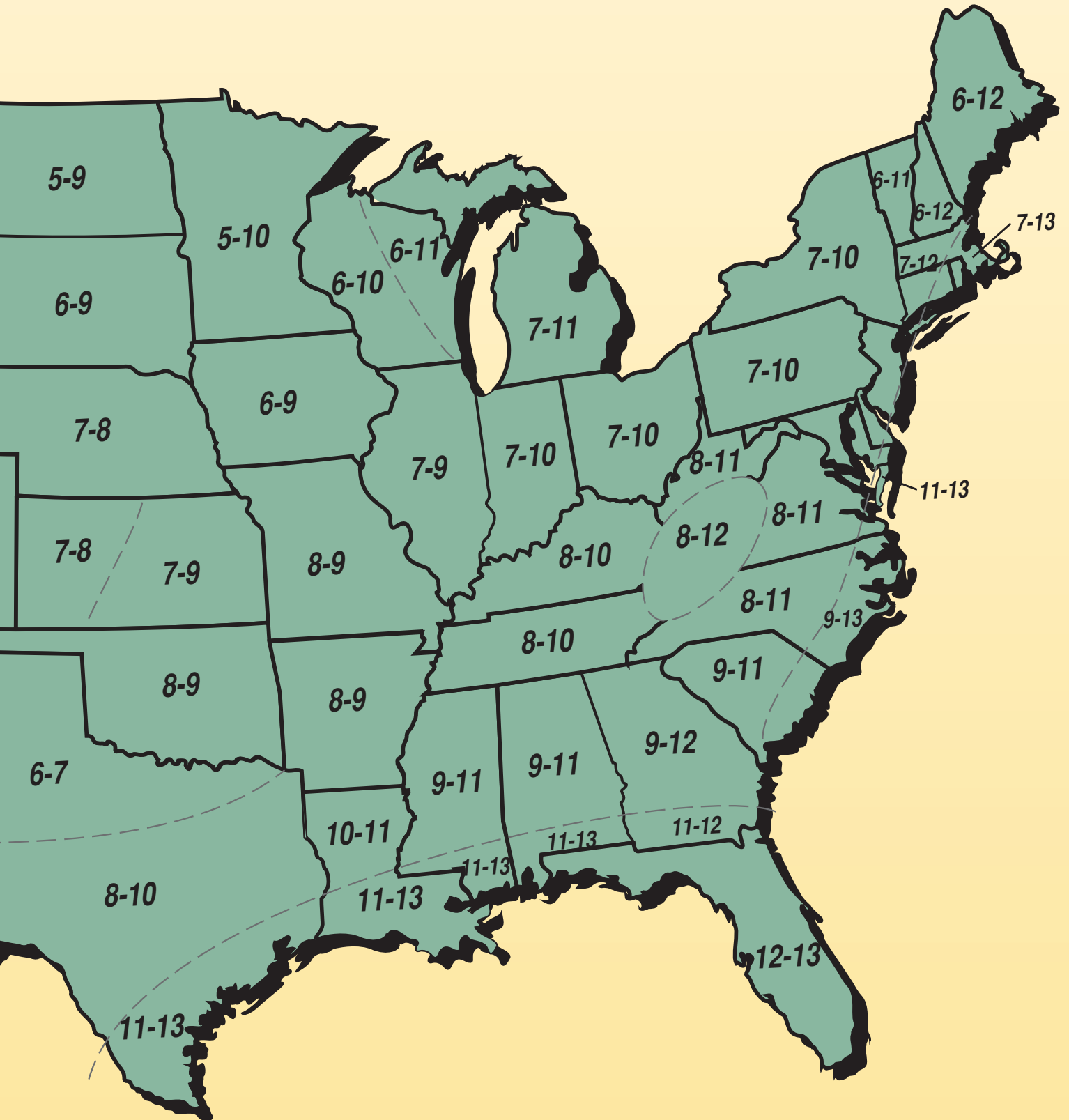

BUILDER'S CHECKLIST

PRE-INSTALLATION EVALUATION OF THE JOBSITE

Job name _____
 Job address _____
 City _____ State _____ Zip _____
 Job telephone _____
 Jobsite superintendent _____
 I verify the jobsite is ready for wood flooring installation _____
 Date _____ (signature of jobsite superintendent)

UNTIL THE FOLLOWING GUIDELINES HAVE BEEN MET, THE JOBSITE IS NOT READY FOR A WOOD FLOORING INSTALLATION.

EXTERIOR CONDITIONS

Gutters and downspouts are properly placed to drain water away from the structure.

Yes _____

Soil surrounding the structure is graded properly to drain water away from the site.

Yes _____

INTERIOR CONDITIONS

All wet trades (drywall, plaster, paint, ceramic tile, etc.) have completed their work.

Yes _____

Air conditioning, heating and ventilation are complete and operating.

Yes _____

The building is enclosed and weather-tight, including all doors and windows in place.

Yes _____

The temperature and relative humidity within the structure are at "normal living conditions" — that is, temperature is between 60 and 80 degrees Fahrenheit and between 30 and 50 percent relative humidity.

Yes _____

Six-mil polyethylene (preferably black) has been installed and covers the entire ground area in the crawl space.

Yes _____

CONCRETE SLAB CONDITIONS

Concrete has been installed for at least 30 days.

Yes _____

If wood flooring is to be installed over a slab, the concrete is flat per specifications.

Yes _____

A vapor barrier has been installed under the slab.

Yes _____

Verified by _____

DELIVERY AND WORKING CONDITIONS

Proper electrical power is available.

120V _____ 220V _____

Driveway and sidewalks are paved.

Yes _____

MOISTURE CONDITIONS

Moisture content of the wood subfloor is no more than 4 percentage points above or below the finish flooring and is within regional moisture content guidelines.

Yes _____

Moisture testing of concrete slab began no sooner than 30 days after the slab was poured. Test results indicate that it is safe for wood flooring installation to begin.

Yes _____

What type of test was used? _____

What were the test results? _____

Testing for Moisture

The determination of moisture content is an essential part of quality control within the flooring installation process. Flooring installers must know the dryness of not only the wood flooring, but its subfloor and the concrete slab beneath it, if one exists. Hand-held electrical tools, called moisture meters, should be part of the toolbox of every flooring contractor, for measuring moisture in subfloors and floors.

Working with moisture meters

Moisture meters have become one of the most critical tools of the trade, yet they are often neglected by those who need them most — flooring contractors. The installer who continues to work without one is simply jeopardizing his jobs. A single moisture-problem installation should be enough to convince him or her to invest in a meter and make use of one of the most cost-effective tools in the business.

Moisture meters have many purposes. They can determine if floor boards are dry enough for an installation to proceed. They can check subfloors and concrete for high moisture levels; they can decide when a second coat of finish can be applied; they can assess

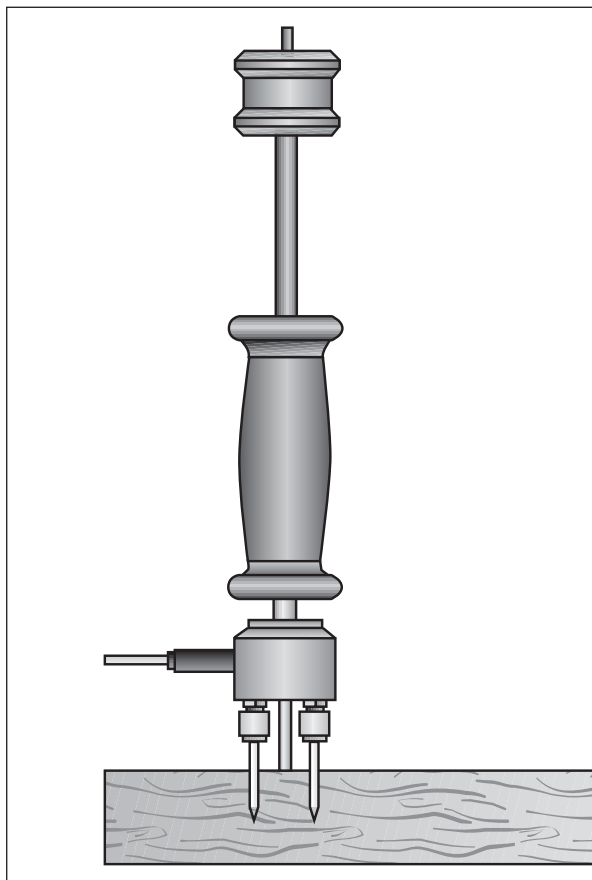

A probe-type moisture meter

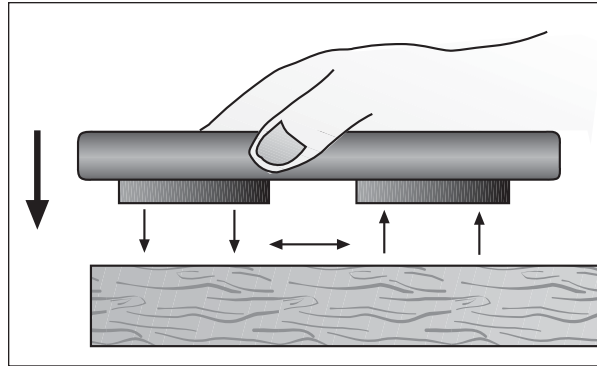

A pinless moisture meter

water damage.

There are two main types of meters — probe and pinless.

The probe type, which is the older method, measures electrical resistance across opposed sets of pins, which are pushed into the wood. The higher the moisture content, the lower the resistance.

Probe-type meters are fast and easy to use. They come with different measurement indicators. The lower-cost units have L.E.D. display lights indicating different moisture levels; the better-quality units have analog or digital displays and provision for different species and wood temperatures.

The pinless, dielectric types, which are also referred to as “non-destructive” because they don’t leave any small holes in the wood, are quite different.

Signal penetration for pinless meters is up to 1 inch for both hardwood and softwood. The meter can be moved across the surface to identify pockets of moisture in a wood block or plank. It is relatively unaffected by temperature. Rough surfaces have very little effect on the reading. Measurements can also be taken through coating, varnish or paint without damage to the surface.

One advantage of probe type meters is that those with insulated pins can measure moisture content at varying depths — you can tell whether the moisture content near the bottom of a board is higher than near the top, for example.

Deciding which kind of moisture meter to buy is a matter of sorting through the features you think you will need, and how often you may use it, and then understanding the various features and benefits. It is important that the meter you choose offers the following:

- A wide moisture content range from at least 6 percent to 30 percent. (The accuracy of readings outside of these limits are generally considered questionable.)
- A clear analog or digital dial.
- The necessary adjustment tables for various species;
- For a probe meter, the ability to take external probes, and a selection of pin sizes.

Testing subfloors

Wood subfloors are actually easy to check for moisture content. Just test for moisture at several locations in the room and average the results. In most regions, a “dry” subfloor that is ready to work on has a moisture content of 12 percent or less. If excessively high readings are obtained, installation should not proceed until the origin of the moisture is identified and moisture problems are remedied. During the winter, an overly moist subfloor can be dried out by running the heat for a few weeks. Air conditioning during the summer will do the same thing.

Before flooring can be installed, the moisture content of the subfloor should be within 4 percentage points of the flooring that will be laid on it.

If the moisture content between the flooring and subflooring varies more than 4 percentage points, then the flooring should not be installed.

Testing concrete

As concrete moves through its initial drying period, regular checking of moisture content can start after 30 days. In most cases it will take 60 days or more before the slab is dry enough for wood flooring installation to proceed. Excess moisture in the concrete will cause problems such as condensation or failure of the adhesive under the flooring.

Moisture conditions in concrete slabs that ultimately create moisture problems in flooring are not the flooring contractor’s responsibility, but it is the contractor’s responsibility to ensure that potential moisture problems are resolved before installation begins. Unless the flooring contractor takes the initiative to determine the potential problems, through testing for moisture content, he is the one who will get called by the unhappy homeowner — because the buckling wood is the only result the homeowner sees.

A flooring contractor can begin his determination with some subjective and logical questions: What is the history of other homes in the area, as well as the history of the building, the quality of the building and the quality of the slab?

Also, what is the age of the concrete? (An installer should not accept a slab as “ready” on age alone.) What is the concrete’s visual appearance? (The color of good, healthy concrete should be almost sugar-white. Any concrete that is gray, brown, tan or other such off-white colors should be suspected of having contaminants, admixtures or other problems unsuitable for flooring. It is virtually impossible, however, to judge a concrete slab’s moisture condition on the basis on color alone.)

Concrete slabs must meet a moisture specification when tested in accordance with the prescribed procedures, at the time of installation of the flooring, and also at any future date. **The moisture specification**

shall be that the emission of moisture vapor from the floor shall not exceed 3 pounds per 1,000 square feet per 24 hours.

Concrete should normally be a minimum of 60 days old before wood flooring is installed on top, unless moisture testing indicates acceptable moisture content before that time. Anything short of that, and the general contractor is making demands of the flooring installer that could result in moisture problems down the line.

Rely on flooring manufacturers’ recommendations for your definition of what qualifies as “acceptable moisture content,” as well as for which type of moisture testing each manufacturer prefers.

Testing for moisture in concrete can be accomplished using specially designed and calibrated moisture meters, and there are also several types of physical tests that can be used. The most common types of tests are discussed on page 17.

Electrical testing of concrete

Some meters are designed for concrete use. Regular checking of moisture content of the concrete slab during the drying out period is required to ensure it has reached sufficient dryness to accept the floor covering.

Electrical testing works on the principle of resistance to electricity passing through the moisture in the slab.

When testing concrete slabs, particularly if they are on-grade or below-grade, the moisture condition should be tested not only on the surface, but also in the body of the slab. The reason for testing both the surface and the mid-section is to ascertain if there is continuous moisture movement toward the surface. If the flooring is installed while the slab is in this condition, upward movement of moisture will continue and the moisture will move into the floor. The results are costly and damaging.

As always, tests in multiple locations throughout the slab.

Contact NWFA for sources

There are numerous sources for wood and concrete moisture meters, as well as for the materials needed to perform the calcium chloride test, which is discussed on page 17. Those sources are not listed here, because they are always subject to change. For the latest information on these sources, contact:

The National Wood Flooring Association
233 Old Meramec Station Road
Manchester, MO 63021
Phone: 800/422-4556 (U.S.)
800/848-8824 (Canada)
314/391-5161 (local and international)
Fax: 314/391-6137

Various physical tests of concrete

Here are some other tests that installers employ to check the moisture content of the concrete before starting the installation. All tests should be done at several different locations in a room — typically along exterior walls and walls with plumbing enclosures, as well as over mechanical chases.

THE CALCIUM CHLORIDE TEST: The calcium chloride test is becoming one of the most widely used concrete moisture tests. It's intended to determine the amount of moisture (in pounds) coming through the slab over a 1,000 square foot area in 24 hours. Developed in the 1950s by the Rubber Manufacturers Association as a measure of concrete dryness, it's also known as the RMA test, as well as the "dome" test. The calcium chloride test has been used most often by sheet vinyl installers, but a growing number of wood flooring installers now employ the test as well. Costs can run about \$50 or \$60 per test. As always, refer to flooring manufacturer recommendations, since some believe other tests are more accurate.

The calcium chloride test works by measuring changes in weight of anhydrous calcium chloride crystals.

A small plastic dish of crystals is sealed with a plastic tape. The entire dish is weighed on a gram scale prior to exposure and the weight, date and time the test was started must be recorded. The lid is then opened, and the dish of crystals is carefully set down on the concrete for 60 to 72 hours. The dish is enclosed within a 7-by-10-inch cover, which is sealed to the concrete. During this time, the only source of moisture being absorbed by the crystals is what can evaporate out of the covered concrete surface area.

At the end of the test, the dome is removed and the lid is placed back on the dish and sealed. Again the dish is weighed on the gram scale and the date and time are marked. The change in weight is multiplied by a constant and divided by hours to provide an estimated rate of evaporation, in pounds.

Pounds is the equivalent weight of the water that evaporates out of a 1,000-square foot surface area during 24 hours. Water weighs 8.3 pounds per gallon. If the test reports 8.3 pounds emission, then one-gallon of water is leaving a 1,000 square foot surface area in 24 hours.

A conservative but generally recommended allowable amount of moisture emission as expressed by the calcium chloride test is 3.0 pounds per 1,000 square feet per 24 hours at the time of the installation of the flooring.

THE POLYFILM TEST: Pieces of 24-inch squares of polyfilm are placed at several points on the subfloor, sealed to the subfloor on all four sides with silver

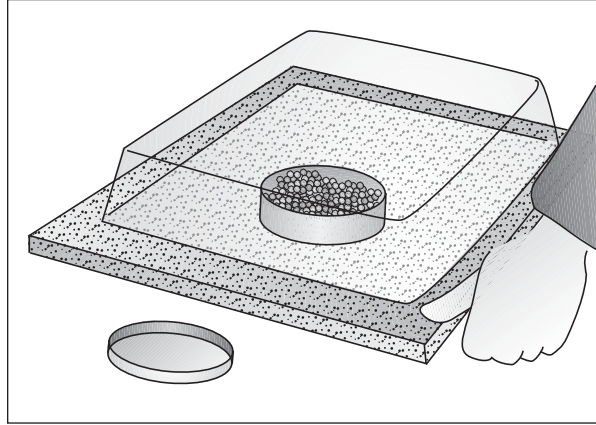

The calcium chloride test: A sealed dish of crystals is weighed, then the lid is removed and the dish is placed under a plastic cover, where the crystals are exposed to whatever moisture remains in the concrete slab. After 60 to 72 hours, the dish is resealed and weighed again. The change in weight, through a mathematical formula, provides a measure of how much water is evaporating from the slab.

duct tape. After 24 hours, the patches are removed and inspected for signs of condensation. If beads of water are found on the subfloor or the concrete appears darker, further testing is necessary. If there is no indication of moisture under the polyfilm, the installation may proceed. The reading is valid at 24 hours, but it's even better if the test can stay in place until 72 hours have passed.

The polyfilm test can also be "accelerated" by using a heat source (such as a 40 to 60 watt light-bulb) 18 inches above the plastic.

For more information on using the polyfilm test, refer to ASTM test method D4263.

THE HUMIDITY TEST: A relative humidity meter is placed on the surface of the concrete next to interior walls and pillars. The meter is covered with an 18-inch-square polyethylene sheet, sealed at the edges with tape. The test should run 24 hours on a slab four inches thick, up to 72 hours on a thicker slab. If the meter reading stays at 65 percent or above, the slab is too wet.

THE PHENOLPHTHALEIN TEST: This uses a 3 percent phenolphthalein solution in water-free ethyl alcohol. Dime-sized holes, ¼-inch deep, are drilled in various areas of the slab, particularly around walls. Then two drops of the solution are applied into each of the drilled areas. If there's no color change in the solution, there should not be enough moisture to affect the installation. But if the phenolphthalein turns pink or dark red within five minutes, further testing must be done with a more precise method.

For the Flooring Contractor or Retailer: Troubleshooting Moisture-related Situations

Assessing the responsibility for hardwood floors affected by moisture is sometimes difficult because of the complexity of contributing causes, and because the source of the moisture is seldom obvious.

It is often convenient for all parties to point the finger of responsibility at the flooring contractor, the distributor or the manufacturer of the flooring. In some cases, of course, the flooring itself is responsible, but most of the shrinkage and expansion problems with wood floors involve jobsite moisture conditions. These conditions cannot be controlled by flooring manufacturers, nor in many instances by sub-contractors responsible for installing the wood floor, unless interior humidities are maintained at proper levels.

By using responsible practices for the installation, and by checking on the various moisture contents at the site, the flooring contractor is taking the necessary steps toward a successful installation.

Yet, the fast pace of new-home construction accounts for some practices that are detrimental to hardwood floors and many other building products. When builders' schedules demand that wood floors be put down before all doors and windows are in place, or before concrete and masonry are dry, the homeowner ultimately pays with the inconvenience of putting up with a faulty hardwood floor.

It is the business of each of the parties to know and control those areas of responsibility in his or her domain, within reason. But some good insurance against getting a callback a few months after the installation is customer education.

Customer education about proper maintenance procedures and normal expectations for their wood flooring is part of the installation. The owner should be aware of the installer's limits of liability. The owner should also know how wood reacts to changing temperature and humidity conditions and what constitutes acceptable cracks between boards that will disappear over time.

Pages 19-20 of this manual provide a two-page brief that the contractor can leave with the customer as part of his or her education. But if complaints occur down the road, here are some common-sense guidelines on how to handle them like a professional.

How to handle an angry customer

- *Listen!* Except for the few "professional complainers" who use complaints to avoid contractual obligations, most homeowners just need to vent their frustration — and you need to know the problem. So listen all the way through the homeowner's remarks, even if they become offensive. The owner may feel that to get some attention he must shout at somebody. Let that happen. When it is off his chest, he will probably be much easier to deal with.
- *Be sympathetic.* Never take a complaint personally — not even a tirade. You can express your concern without taking sides, even if you must later dispute much of the owner's view of the problem. You can't really blame the owner for wanting the problem fixed.
- *Be objective.* Do not allow emotions or prior knowledge to get in the way of handling facts as facts. There is no percentage in arguing. Just collect all the facts. By the same token, keep in mind that a few boards do not always make a legitimate complaint.
- *Log all information,* from the first contact through a full inspection. Initially, get all pertinent data such as owner's name, address and phone, plus the same information on the builder, retailer or contractor; what the product is, brand, when purchased, quantity, when installed and when finished. And get a full description of the problem at the outset.
- *Report the complaint to your supplier* if you feel the responsibility may lie there, or if you need some special assistance. Report progress to the homeowner or builder — in writing with a copy for yourself — particularly if progress toward resolution is delayed.
- *Inspect the floor as soon as possible.* Delays can create a second complaint, and do little for your credibility. Do not make a snap judgment of the problem, and above all, do not report your findings on the spot to the homeowner or builder, or any other interested party.

Complete the full inspection procedure, then assemble your facts for full analysis before deciding the reason for the complaint. Then report your findings in writing. What you say in conversation can be misinterpreted, and is almost always remembered wrong. What is written doesn't change, and doesn't invite argument before you are finished having your say.

Note: The National Wood Flooring Association has a Complaint/Checklist form that can be used for jobsite inspections and complaint resolution. It is available to NWFA members only. Contact NWFA at the address or phone numbers listed on the back cover for more information.

For the Customer: How to Spot and Avoid Trouble in Hardwood Floors

In a comfortable home with slight humidity variations through the seasons, wood flooring responds by expanding and contracting. These changes may be noticeable. During warm, humid weather, wood expands. During dry weather, wood contracts. This seasonal movement is a normal characteristic of wood flooring, and it never stops, regardless of the age of the wood. One of the best ways to ensure that wood flooring will give the performance homeowners expect is to install humidity controls and ensure that they are functioning before the flooring is installed.

Working with humidity controls

A homeowner who chooses hardwood flooring is making an investment in a floor that will last 40 years or more, and he or she should protect that investment by installing humidity controls — a tool that helps the floor maintain a beautiful, trouble-free appearance.

Cracks and separations between boards

Nearly every floor endures some separation between boards. In winter, when homes are heated and the air is dry, wood flooring gives up some of its moisture and therefore shrinks. When that happens, thin cracks appear between. This is normal, and homeowners should be forewarned of this. It is acceptable, and customers should not be calling the installers at the first sign of cracks. Once the indoor heat goes off in the spring, and the indoor environment regains moisture, most of these cracks will close up.

Cracks in winter — in the drier months — may easily develop to the thickness of a dime ($\frac{1}{2}$ inch) for solid $2\frac{1}{4}$ -inch wide strip oak floors. Floors with light-stained woods and naturally light woods like maple tend to show cracks more than darker, wood-tone finished floors.

The cure for cracks? Homeowners should add moisture to the air during dry periods. It's their choice — live with the cracks and wait until spring, or else add humidity by opening the dishwasher after a rinse cycle, switching off the bathroom fan or hanging laundry to dry in the basement near the furnace. Better yet, install a humidifier in the furnace, or an exterior air vent for the furnace burner.

If cracks are a concern, laminated flooring moves less and shows fewer gaps.

Cupping and crowning

"Cupping and crowning" are common complaints that develop with high humidity. Both problems occur across the width of the flooring material.

Cupping is when the edges of a board are high and its center is lower. It can occur after water spills onto the floor and is absorbed by the wood, but high humidity is more often the cause. If the wood expands significantly, compression set can result as the boards are crushed together, deforming the boards at the edges.

Cupping is caused by a moisture imbalance through the thickness of the wood: The wood is wetter on the bottom of the board than on the top. The moisture imbalance can be proven by taking moisture meter readings at different pin depths.

The first step in repairing a cupped floor is to identify and eliminate the moisture source. In the

Cupping and Crowning

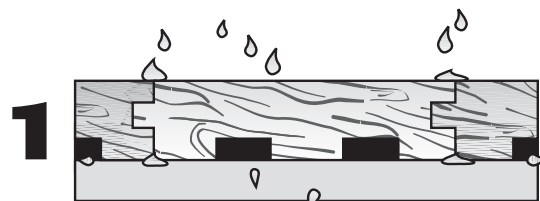

Water spilled on the surface of the wood flooring or rising through the subfloor ends up trapped between the wood flooring and the subfloor.



Cupping occurs when the bottom of the wood flooring remains wetter than the top surface, which dries faster than the bottom.



If the floor is sanded before the boards have had a chance to thoroughly dry and flatten out on their own, the top surface will initially be flat, while the bottoms of the boards remain cupped.

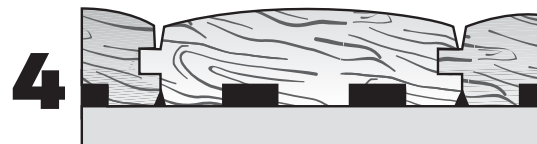

Crowning occurs when the bottoms of the boards eventually dry and flatten out, leaving the tops of the boards with a convex profile.

kitchen, it may be a leak from the dishwasher or ice-maker. From outdoors, it might be the terrain of the lot, with rain and runoff not moving away from the house and foundation. Indoors, the humidity may need to be controlled, or a plumbing leak may be causing excess moisture in the basement, which migrates up into the subfloor and from there into the wood flooring.

Once the source of the moisture is controlled, cupping can usually be cured. The floor may improve on its own as it dries out over time. Other times, fans may be needed to speed the drying process. Once the moisture content has stabilized, the floor can be reassessed. Choices may be to do nothing at all, to recoat the floor or to sand and refinish the floor. **However, it should not be sanded until moisture-meter readings indicate the floor is thoroughly dried.**

Crowning is the opposite of cupping: The center of a board is higher than the edges. Moisture imbalance is sometimes the cause of crowning if excessive moisture is introduced on the top of the floor, perhaps from water used in maintenance or plumbing leaks from an overhead sprinkler system. However, a common cause is that the floor was previously cupped, but was sanded at the wrong time — before the moisture content returned to normal and the board flattened on its own. (See illustration on page 19.)

It should be noted that some slight cupping and crowning may occur naturally, and should be tolerated: The bark side of lumber shrinks and swells more than the side closest to the center of the tree. Largely seasonal in occurrence, it's common in wider planks. Its appearance can be minimized by using a beveled-edge flooring product with a satin finish, rather than square-edge flooring with a high gloss finish.

Buckled floors

The “buckling” of hardwood floors — when the flooring literally pulls away from the subfloor, rising up to several inches in one or more places — is one of the most extreme reactions to moisture that can occur. Fortunately, it is not a common occurrence.

Buckling happens most often after a floor is flooded for a time, but there are numerous other causes. On nailed floors, insufficient nailing, incorrect nails or incorrect subfloor construction are possibilities. On glue-down floors, the causes range from the use of incorrect or insufficient mastics to an inadequate mastic transfer, a subfloor separation or a subfloor contamination.

In flooded hardwood strip flooring, the swelling stress is theoretically high enough to push out walls. However, before that can happen the nails or the glue holding the flooring to the subfloor will usually give way, so that the floor bulges upward.

If buckling floors are caught early, spot repair and replacement may be possible. Once the standing water is removed, several boards may be taken up from the floor so that air can be circulated across and below the floor more effectively. Once the floor has dried to a more stable moisture level, repairs can usually be made.

Some tips on maintenance

The enjoyment of wood flooring depends on some routine but minimal maintenance details. These include:

- Sweep your floors or use a dust mop daily, but do not use a household dust treatment, as this may cause your floors to become slick or dull the finish.
- Vacuum your floor regularly, as often as you would vacuum carpets.
- Clean your floor's coated surface with a lightly dampened cloth using a recommended cleaning product, and according to the manufacturer's directions for use.
- Never damp mop a wood floor. In all cases, use minimum water, because water causes deterioration of the wood itself, as well as the finish.
- Buy a “floor care kit” that your installer or flooring retailer recommends instead of counting on a home-made remedy of vinegar and water to clean your floors. Different finishes have different maintenance requirements, and it's best to follow professional advice in this area.
- Clean light stains by rubbing with a damp cloth.
- Avoid using mops or cloths that leave excessive water on the floor. Never let a spill of water dry on the floor.
- Control humidity levels by use of a dehumidifier or humidifier. You may need to add portable units in some rooms.
- Have your floors recoated periodically as the finish shows wear.
- Do not clean your wood floors with water or water-based products on a regular schedule. Clean only when necessary and clean only the soiled areas.

Wood Flooring Over Radiant Heating

Radiant heating is a growing source of heating in North America, both in residential and commercial installations. Consequently, it's important for installers to understand how radiant heating works with hardwood flooring installations.

Radiant heating does not heat air directly as do more conventional forms of heating, such as baseboard convectors or forced air circulation. Radiant heat is "omni-directional." Unlike warm air, which tends to rise, radiant energy tends to travel in all directions. A large area of mild surface temperatures, such as a warm floor, is capable of transferring as much heat as a small surface area, such as a steam radiator, at high surface temperatures.

Radiant heat beneath wood flooring involves tubing in concrete, or tubing under plywood subfloors.

The most important factor in a successful wood flooring installation over radiant heat is a dry slab and a dry subfloor. **The only sure way to dry a slab and subfloor system is to turn on the radiant heating system before installing the wood flooring.** If this isn't done, moisture left in the slab will enter the wood flooring as soon as the heat is turned on. The result is floors that will expand, contract, shrink, crack, cup and bow excessively. If the heat can't be turned on, then everyone involved — down to the homeowner — should understand and accept the compromises that will appear down the road.

Opinions on the amount of time required vary widely. Some say the heating system should be turned on at least 72 hours before installation, with a preferred time of five to six days. That assumes that the slab has been in place for at least 60 days. (See "Testing concrete" on page 16.) If the slab is relatively new, the recommendation is to have the heating system turned on for 30 to 60 days before installing wood floors. As always, follow the recommendations of your wood flooring manufacturer.

Wood dries rapidly when the heat is first turned on. It dries to a lower moisture content toward the end of the heating season. When the radiant heat is turned off, moisture once again starts to seep into the wood subfloor and radiant slab. Abruptly turning on the radiant heat in the fall will subject wood flooring to rapid and easily noticed movement: Evidence of this movement will be cupping or crowning of the boards. Finally, shrinkage cracks will appear between individual floor boards. Alternatively, gradually turning the heat on before the first really cool day will begin the seasonal movement more gradually. Thus, the movement of the floor will be much less noticeable. As always, humidity controls can help offset flooring expansion and contraction.

Not all species of wood are good candidates for an installation over radiant heating. It's best to follow the manufacturer's recommendation for a species' suitability over radiant heat. When possible, choose a

species that is known for its stability. Quartersawn or rift-sawn flooring is preferable to plainsawn in the search for stability. Strip flooring is also a better choice than plank flooring, because narrow boards expand and contract less than wide boards do. Using narrow boards also means there are more seams in a floor to take up movement. Because of its dimensional stability, laminated flooring is another good choice.

Radiant heating systems are currently designed to run cooler than they did years ago, although water supplied to the systems generally range from 90 degrees to 140 degrees. In years past, when water temperatures exceeded 140 degrees, wood fibers were repeatedly traumatized, causing stress fractures, gaps and twisting. Repeated heating and cooling also broke down the adhesive that bonded the hardwood to the slab.

But today, a set of thermostat controls can help avoid those problems. It is recommended to have three thermostats — one to control the tubing water supply temperature; one to control the room temperature with different zone controls; and one for outside the house. This three-thermostat system is kindest to wood flooring, because it moderates the floor temperature. People tend to crank up the heat when they're cold, but with three thermostats, the system adapts itself to conditions both inside and out. The outside thermostat gears up the system for the arrival of colder weather, and a thermostat adjusting the control water temperature on the tubing will keep the temperature at the homeowner's comfort level.

Four Types of Radiant Heat Installation

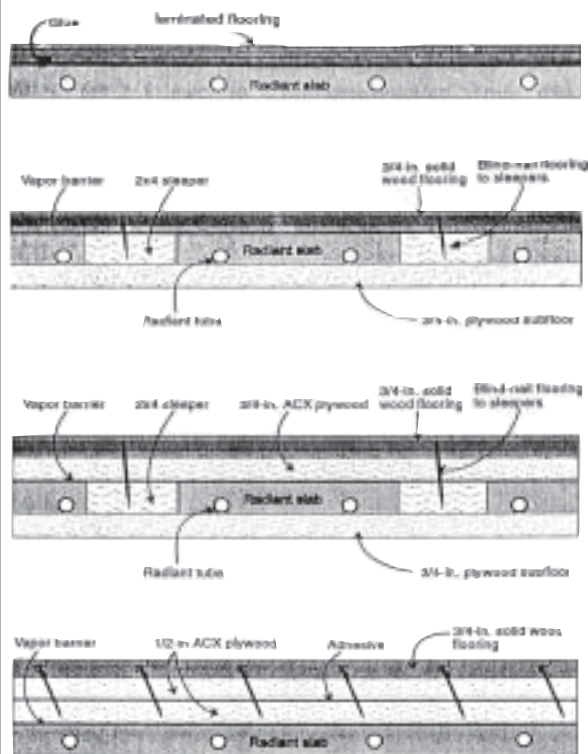

INDEX

Acclimation of wood	4, 11	Moisture meters	15
at the jobsite	11	pinless moisture meters	15
at the warehouse	11	probe moisture meters	15
Builder's checklist	14	readings on packaging	6
Basements	7	Moisture retarders	8, 9, 10
Builder's checklist	14	felt paper	9, 10
Calcium chloride test	17	over subfloors	9
Capillary rise	8	polyethylene sheets	8, 9, 10
Concrete	8, 10, 16, 17, 21	Phenolphthalein test	17
calcium chloride test	17	Polyfilm test	17
electrical testing of	16	Radiant heating	21
humidity test	17	Relative humidity	5, 9
moisture from	8, 10	Sources of moisture	8, 9, 10
phenolphthalein test	17	capillary rise	9
polyfilm test	17	concrete	10
radiant heating	21	crawl spaces	8
subfloors over	9	ground water	8
testing for moisture	16	house	9
Cracks and separations	19	mechanical systems	9
Crawl spaces	8	new construction	8
Cupping and crowning	19	relative humidity	9
Dimensional stability	4, 6	subfloors	9
dimensional change coefficient.....	6	surface water	8
Equilibrium moisture content	5	Subfloors	9, 16
Flooring		moisture from	9
laminated flooring	4, 7	testing for moisture	16
maintenance	20	Testing for moisture problems	15, 16
over radiant heating	21	moisture meters	15
seasonal movement	19	testing concrete	16
Homes: Exterior		testing subfloors.....	16
below-grade, on-grade, above-grade.....	7	Trees	3, 4
construction of	7	fibers	3, 4
water table	8	live	3, 4
Homes: Interior		Troubleshooting	18
everyday sources of moisture	9	buckled floors	20
flooring in basements	7	cracks and separations.....	19
flooring maintenance tips.....	20	cupping and crowning.....	19
humidity and temperature chart.....	5	dealing with customers.....	18
humidity controls	19	Vapor barriers	8, 9, 10
"normal living conditions"	11	Walk-out basements	7
Humidity and temperature chart	5	Wood	
Humidity test	17	dimensional stability	4, 6
Laminated flooring	4, 7	fibers	4
Lumber seasoning	5	fiber saturation point.....	4, 5
Maintenance	20	hygroscopic qualities	4
Moisture content	4, 5, 6	movement in boards	4
changes in EMC	5	oven-dry weight	4
definition	4	quartersawn vs. plainsawn	6
equilibrium moisture content	5	shrinkage and swelling	4
regional variations	6		
map of	12-13		

SOURCES AND CREDITS

NWFA TECHNICAL AND EDUCATION COMMITTEE

- John Hoopes, 3M Company, committee chair
- Coley Armstrong, Basic Coatings
- Joe Audino, Rode Brothers Floors
- Don Bollinger, Wood Floor Products
- Jeff Buysse, Minuteman International
- Bill Carnel, 3M Company
- Don Conner, Harris-Tarkett Inc.
- Tom Conser, The Roane Company
- Tom Derleth, Indiana Hardwood Specialists
- Galen Fitzel, 3M Company
- Kevin Hacke, Maple Flooring Manufacturers' Association
- John Mayers, Dura Seal
- Tim McCool, Dri-Tac Adhesives Group
- Mickey Moore, National Oak Flooring Manufacturers' Association
- Neil Moss, Hartco Flooring
- Bob Vanderlinden, Bruce Hardwood Floors
- Dick Walters, Erickson's Flooring & Supply

THE FOLLOWING SOURCES WERE CONSULTED IN COMPILING THIS PUBLICATION:

- *Wood Handbook: Wood as an Engineering Material (Agriculture Handbook 72)*, Forest Products Laboratory, Forest Service, U.S. Department of Agriculture, revised 1987.
- *Hardwood Floors: Laying, Sanding and Finishing*, Don Bollinger, Taunton Press, 1990.
- *Residential and Light Building Construction*, Stephens W. Nunnally and Joan A. Nunnally, Prentice-Hall Inc., 1990.
- *Wood as Building and Hobby Material*, Hans Kubler, John Wiley & Sons, 1980.
- *Construction Principles, Materials and Methods*, Harold B. Olin, The Institute of Financial Education, 1975.
- *Water in Wood*, Christen Skaar, Syracuse Wood Science Series, Syracuse University Press, 1972.
- *An Introduction to the Seasoning of Timber*, W.H. Brown, The MacMillan Company, 1965.

THE FOLLOWING INDIVIDUALS, ORGANIZATIONS AND COMPANIES CONTRIBUTED INFORMATION, SERVED AS REVIEWERS, OR BOTH:

- Bast Hardwood Floors, John Bast
- Beckett Brothers Floor Company, Steve Beckett
- Boone Flooring, Daniel Boone
- Brickman Wood Floors, Howard Brickman
- Buffalo Hardwood Floor Center, Jim Carroll
- C.A. Newell Company, Monte Asken,
- Clarke Industries
- Design Flooring Distributors Inc., Wayne Cotton
- Design Hardwood Products, John Goss
- Diamond "W" Floor Covering Inc., Dennis Parks
- Dynamic Laser Applications, Jim Garth
- Franklin International, Derick Cooper
- Golden State Flooring Company, Chris Coates
- Great American Hardwood Floors, Larry Bailey
- Hartco Flooring, Gene Failor
- Junckers Hardwood, John Safarik
- McSwain Hardwood Floor Company, Ralph McSwain
- Mesquite Products of Texas, Jim Tomerlin
- National Oak Flooring Manufacturers' Association
- Plaza Hardwood Inc., Paul Fuge
- University of Massachusetts, Dr. Bruce Hoadley
- University of Wisconsin, Dr. Gene Wengert
- U.S. Forest Products Laboratory
- Wagner Hand-Held Electronic Products, Cynthia Biondi
- Woodpecker Hardwood Floors, Terry Noble